

PORTABLE DVD

www.facebook.com/denverelectronics

Before connecting, operating or adjusting this product,
please read this user's manual carefully and completely.

DENVER[®]

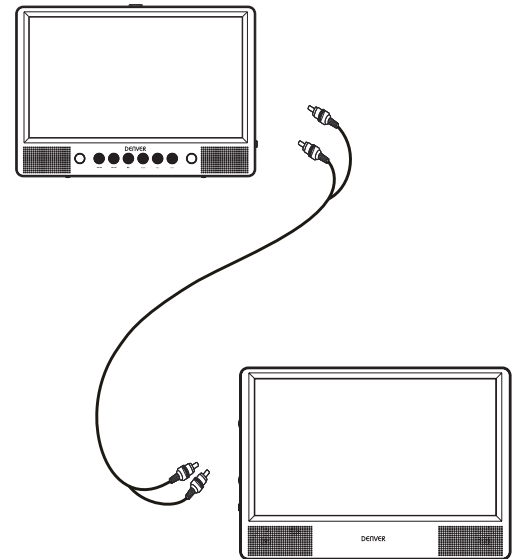

USER'S MANUAL MTW-1086 TWIN

Important Safety Instructions

1. Warning: To reduce the risk of electric shock, do not remove the cover or back. There are no user-serviceable parts inside. Refer servicing to qualified personnel.
2. Warning: To prevent fire or electric shock hazard, do not expose the unit to rain or moisture.
3. Do not expose the Adaptor and portable DVD to water (dripping or splashing) and no objects filled with liquids, such as vases, should be placed on the unit.
4. Keep the portable DVD away from direct sunlight and heat source such as radiators or stoves.
5. Do not block the ventilation openings. Slots and openings on the unit are provided for ventilation. The openings should never be blocked by placing your portable DVD on a cushion, sofa or other similar surface.
6. Do not place the portable DVD on unstable cart, stand, tripod, bracket or table. The unit may fall, resulting in possible damage or injury.
7. Never place heavy or sharp objects on the LCD panel or frame.
8. Only use the AC adaptor included with portable DVD. Using any other adapter will void your warranty.
9. The plug of AC adaptor is used as the disconnect device, the disconnect device shall remain readily operable.
10. Unplug the power from the outlet when the unit is not in use.
11. WARNING: Excessive sound pressure from earphones or headphones can cause hearing loss.



12. WARNING: Only use attachments/accessories specified provided by the manufacturer, the portable DVD is supplied by AC adapter, the AC adapter is used as disconnect device, the disconnect device shall remain readily operable.

This marking indicates that this product should not be disposed with other household wastes throughout the EU. To prevent possible harm to the environment or human health from uncontrolled waste disposal, recycle it responsibly to promote the sustainable reuse of material resources. To return your used device, please use the return and collection systems or contact the retailer where the product was purchased. They can take this product for environmental safe recycling.



Safety Precautions

WARNING
RISK OF ELECTRIC SHOCK
DO NOT OPEN

- Warning: This digital video disc player employs a laser system. Use of controls, adjustments, or the performance of procedures other than those specified herein may result in hazardous radiation Exposure.
- Warning: To prevent direct exposure to laser beam, do not open the enclosure. Visible laser radiation when open.
- Warning: Never stare directly into the laser beam.
- Caution: Do not install this product in a confined space such as a book case or similar unit.
- Warning: more than 250mm USB extension cord is prohibited to use for USB port.

N Notes on Copyrights:

It is forbidden by law to copy, broadcast, show, broadcast via cable, play in public, or rent copyrighted material without permission.

This product features the copy protection function developed by Macrovision. Copy protection signals are recorded on some discs. When recording and playing the pictures of these discs picture noise will appear. This product incorporates copyright protection technology that is protected by method claims of certain U.S. Patents and other intellectual property rights owned by Macrovision Corporation and other rights owners. Use of this copyright protection technology must be authorized by Macrovision Corporation, and is intended for home and other limited viewing uses only unless otherwise authorized by macrovision Corporation. Reverse engineering or disassembly is prohibited.

SERIAL NUMBER:

You can find the serial number on the back of the unit. This number is unique to this unit and not available to others. You should record requested information here and retain this guide as a permanent record of your purchase.

Model No. _____
Serial No. _____
Date of Purchase _____

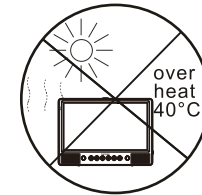

In Car Installation by mounting bracket

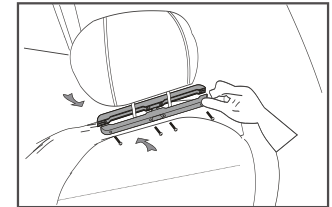
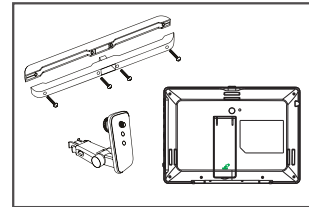

1. Separate the bracket by taking down the screws on both side of the bracket.
2. Take out 4pcs screws of long part of the bracket.

3. Install the long part of the bracket to the steel pipe beneath the back of the seat, then lock up the screw.

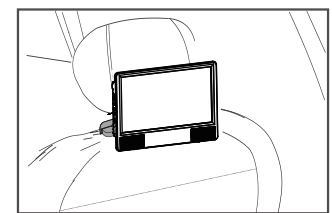
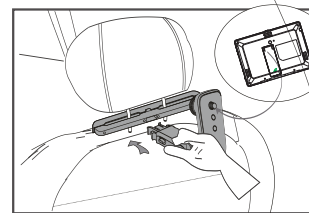

4. Insert the other part of the bracket.

5. Put the player to the indicated screw hole and tighten the screw.

In Car Installation with straps

1. Fit the straps to the DVD Player / Monitor as required.

The DVD player will fit to the mount in this position, as shown below.



Turn the player around so the backs are facing you.

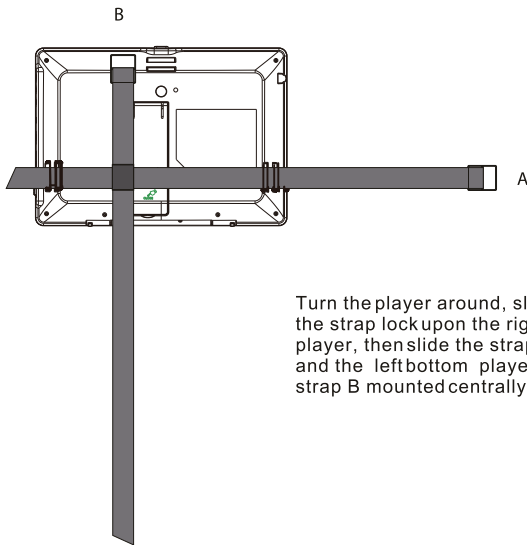

Turn the player around, slide the strap a through the strap lock upon the right bottom of the DVD player, then slide the strap through the strap B and the left bottom player as shown. Enter the strap B mounted centrally.

2. Fitting the straps to the headrest.
 - a. Fitting the straps to the headrest.

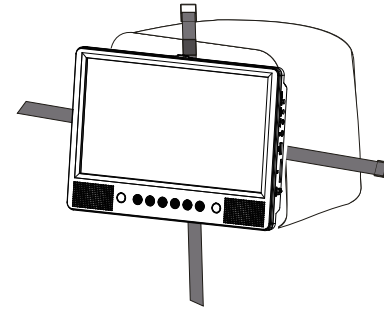

Fit the straps around the headrest and engage the 2 trident clips. Ensure clips are securely fastened.

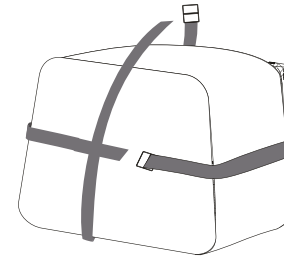

Pull the straps tight using the adjustment. Tuck the loose ends into the strap tidy.

NOTE:

Be sure to complete the installation then use MTW-1086 TWIN in the car. For MTW-1086 TWIN installation is recommended that the DVD Player is on the LEFT headrest, to ensure a neat cable run to the monitor, as shown below:



Main Unit Controls

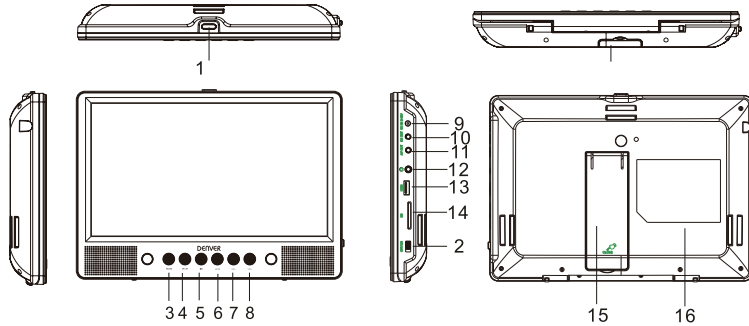

1. Open knob
2. Power ON/OFF switch
3. ◀/◀◀ Long press for previous, short press for fast rewind
4. ▶/▶▶: Long press for next, short press for fast forward
5. ⏸ PLAY/PAUSE button
6. MODE button
7. Volume -
8. Volume +
9. DC IN 9-12V
10. DC OUT
11. AV OUT
12. Earphone jack
13. USB Port
14. SD card slot
15. Bracket
16. Rating label position

Monitor View

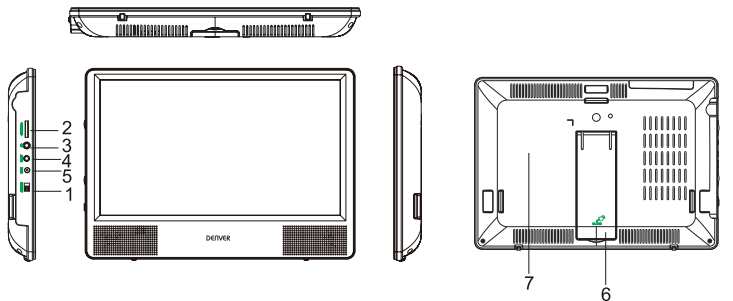

1. Power ON/OFF
2. Volume knob
3. Earphone jack
4. AV IN
5. DC IN 9-12V
6. Bracket
7. Rating Label Position

The Remote Control

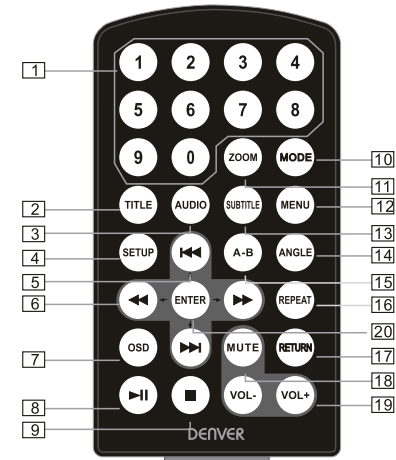

1. Number button
2. TITLE (To display title information)
3. AUDIO (To select audio language)
4. SETUP (To go to or exit setup menu)
5. ◀◀▶▶ Previous/Next button (To go to previous/next chapter or scene during playing)
6. ◀◀▶▶ Fast forward/backward button (To scan forward/backward at 2, 4, 8, 16, or 32 times)
7. OSD (To display disc information during playing such as elapsed and remaining time)
8. ⏸ Play/pause
9. ■ Stop (press once to stop playback, then press ▶ to resume playback from the point where you stopped; press stop button twice to stop playback completely)
10. MODE (To select the source)
11. ZOOM (To zoom in/out the image during the playback)
12. MENU (To enter or exit root menu)
13. SUBTITLE (To select subtitle language when playing DVD disc)
14. ANGLE (To change viewing angle when playing disc with multi-angle)
15. A-B (Repeat a specific portion from point A to B, press it again to cancel repeat playing)
16. REPEAT (To repeat playing title, chapter or track)
17. RETURN (To return to the main menu)
18. MUTE (To turn to mute)
19. VOL +/- (To adjust the volume)
20. ENTER (To confirm)

System Setup

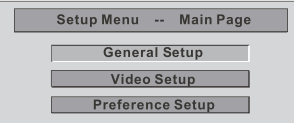
 <p>Setup Menu -- Main Page</p> <p>General Setup</p> <p>Video Setup</p> <p>Preference Setup</p>	<p>Press "Setup" button, the main menu will be displayed on the screen</p> <p>In the General Setup Page, Press ►► button to highlight this item.</p> <p>Press ENTER button to access.</p> <p>Press ◀◀►► button to select the setting.</p> <p>Press ENTER button to confirm your selection.</p> <p>Press ◀◀ button to exit.</p>
--	--

General Setup Page

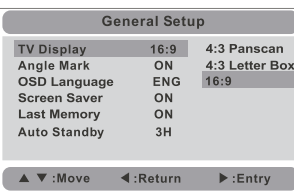
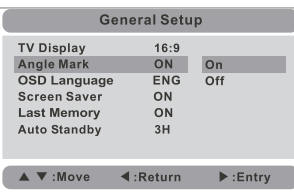
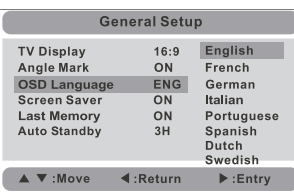
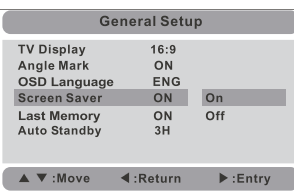
 <p>General Setup</p> <p>TV Display 16:9 4:3 Panscan</p> <p>Angle Mark ON 4:3 Letter Box</p> <p>OSD Language ENG 16:9</p> <p>Screen Saver ON</p> <p>Last Memory ON</p> <p>Auto Standby 3H</p> <p>▲▼:Move ◀:Return ▶:Entry</p>	<p>TV display: Enter this option, user can set screen display format(4:3PS,4:3LB,16:9) The default is "16:9"</p> <p>Note: ☆ The function depends on the display ratio with which the DVD disc is recorded. ☆ Please choose "Wide(16:9)" when using a 16:9 wide screen TV set.</p>
 <p>General Setup</p> <p>TV Display 16:9</p> <p>Angle Mark ON On</p> <p>OSD Language ENG Off</p> <p>Screen Saver ON</p> <p>Last Memory ON</p> <p>Auto Standby 3H</p> <p>▲▼:Move ◀:Return ▶:Entry</p>	<p>Angle Mark: Enter this option to set the angle during playback. Optional setting: ON, OFF</p> <p>The default is ON</p>
 <p>General Setup</p> <p>TV Display 16:9 English</p> <p>Angle Mark ON French</p> <p>OSD Language ENG German</p> <p>Screen Saver ON Italian</p> <p>Last Memory ON Portuguese</p> <p>Auto Standby 3H Spanish</p> <p>Swedish</p> <p>▲▼:Move ◀:Return ▶:Entry</p>	<p>OSD Language: In the option user can set OSD menu language English.</p> <p>The default: English</p>
 <p>General Setup</p> <p>TV Display 16:9</p> <p>Angle Mark ON</p> <p>OSD Language ENG</p> <p>Screen Saver ON On</p> <p>Last Memory ON Off</p> <p>Auto Standby 3H</p> <p>▲▼:Move ◀:Return ▶:Entry</p>	<p>Screen Saver: Enter this option to set whether to activate the screen saver function.</p> <p>The default is ON.</p>

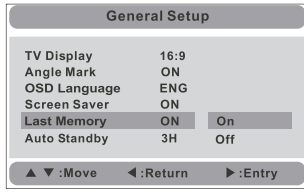
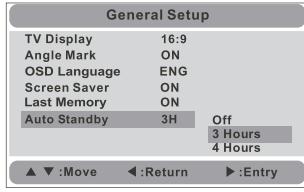
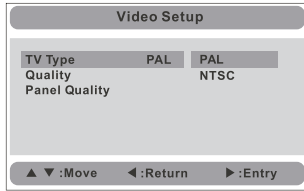
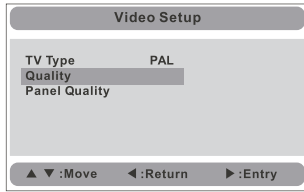
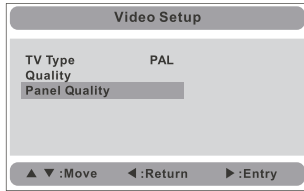
 <p>General Setup</p> <p>TV Display 16:9</p> <p>Angle Mark ON</p> <p>OSD Language ENG</p> <p>Screen Saver ON</p> <p>Last Memory ON On</p> <p>Auto Standby 3H Off</p> <p>▲▼:Move ◀:Return ▶:Entry</p>	<p>Last Memory: Enter this option to set last memory. Optional setting: On, Off The default is : On</p>
 <p>General Setup</p> <p>TV Display 16:9</p> <p>Angle Mark ON</p> <p>OSD Language ENG</p> <p>Screen Saver ON</p> <p>Last Memory ON</p> <p>Auto Standby 3H Off</p> <p>3 Hours</p> <p>4 Hours</p> <p>▲▼:Move ◀:Return ▶:Entry</p>	<p>Auto Standby: Enter this option to set different auto standby time function.</p> <p>The default is 3 hours.</p>
<h3>Video Setup Page</h3>	
 <p>Video Setup</p> <p>TV Type PAL PAL</p> <p>Quality NTSC</p> <p>Panel Quality</p> <p>▲▼:Move ◀:Return ▶:Entry</p>	<p>TV Type: Enter this option to select TV type(PAL,NTSC) The default is PAL.</p>
 <p>Video Setup</p> <p>TV Type PAL</p> <p>Quality</p> <p>Panel Quality</p> <p>▲▼:Move ◀:Return ▶:Entry</p>	<p>Set the Video Quality of AV OUT</p>
 <p>Video Setup</p> <p>TV Type PAL</p> <p>Quality</p> <p>Panel Quality</p> <p>▲▼:Move ◀:Return ▶:Entry</p>	<p>Set the Video Quality of PANEL</p>

Preference Page

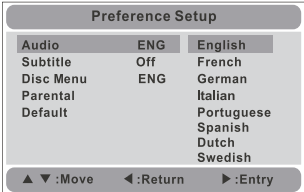
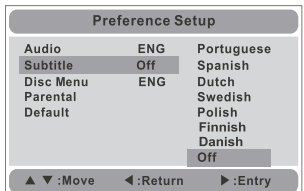
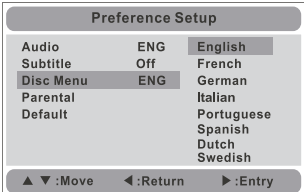
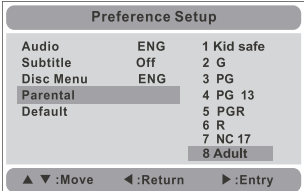
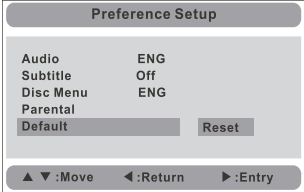
	<p>Audio: Enter this option, user can select preferred audio language for DVDs.</p> <p>Note: The audio language depend on the material on each disc.</p>
	<p>Subtitle: Select your preferred language to show the subtitles on the screen. The default is OFF</p>
	<p>Disc Menu: This function allows you to choose the menu language stored on the disc.</p> <p>Note: the disc menu languages depend on the information available on the disc.</p>
	<p>Parental: Enter this option to set the parental control level to some unsuitable disc scenes being watched by the children. Optional parental control levels: KID SAFE, G, PG, PG 13, PGR, R, Nc17, ADULT.</p> <p>The default is ADULT. The default password is 8888.</p>
	<p>Default: Select this item and press "ENTER" button to reset.</p>

Parameters and Specifications Electrical parameters

Item	Standard Requirement	
Power requirements	: AC 100-240V, 50/60 Hz	
Power consumption	: < 9W	
Operating humidity	: 5% to 90%	
Output	VIDEO OUT	: 1 Vp-p (75Ω)
	AUDIO OUT	: 1.0 Vrms (1 KHz, 0 dB)
	AUDIO	: Speaker: 1WX2, Earphone output

System

Laser	: Semiconductor laser, wavelength 650 nm
Signal system	: NTSC / PAL
Frequency response	: 20Hz to 20 kHz (1dB)
Signal-to-noise ratio	: More than 80 dB (ANALOG OUT connectors only)
Dynamic range	: More than 80 dB (DVD / CD)

N Note: Design and specifications are subject to change prior notice.

AC/DC adapter

Manufacturer's name or trade mark, commercial registration number and address	Shenzhen Teka Technology Co., Ltd. Address: Building A, No.21, XiFu Road, Red Star Community, SongGang Street Baoan District, Shenzhen, Guangdong Province, 518105, P.R. China
Model identifier	TEKA012-1201000EU
Input voltage	100-240V
Input AC frequency	50/60Hz
Output voltage	12.0V
Output current	1.0A
Output power	12.0W
Average active efficiency	83.09% at 115V/60Hz 83.38% at 230V/50Hz
Efficiency at low load(10%)	81.63% at 115V 60 Hz 76.43% at 230V 50Hz
No-load power consumption	0.044W at 115V 60Hz 0.057W at 230V 50Hz

Please notice - All products are subject to change without any notice.
We take reservations for errors and omissions in the manual.

ALL RIGHTS RESERVED, COPYRIGHT DENVER ELECTRONICS A/S

DENVER®

www.denver-electronics.com



Electric and electronic equipment and included batteries contains materials, components and substances that can be hazardous to your health and the environment, if the waste material (discarded electric and electronic equipment and batteries) is not handled correctly.

Electric and electronic equipment and batteries is marked with the crossed out trash can symbol, seen below. This symbol signifies that electric and electronic equipment and batteries should not be disposed of with other household waste, but should be disposed of separately.

As the end user it is important that you submit your used batteries to the appropriate and designated facility. In this manner you make sure that the batteries are recycled in accordance with legislation and will not harm the environment.

All cities have established collection points, where electric and electronic equipment and batteries can either be submitted free of charge at recycling stations and other collection sites, or be collected from the households.

Additional information is available at the technical department of your city.

DENVER ELECTRONICS A/S

Omega 5A, Soeften

DK-8382 Hinnerup

Denmark

www.facebook.com/denverelectronics